

PRODUCT CODE: C6
CABLE CLEAT

DESCRIPTION

No. 6 Cable Cleat: 15.2mm Max Cable Outer Diameter

FINISH

Black

MATERIAL

LDPE

PACKAGING

Packed in qty 100

ADDITIONAL NOTES

Designed for clamping & securing armoured cables
High strength & impact resistance
Temperature range -35oC to 85oC

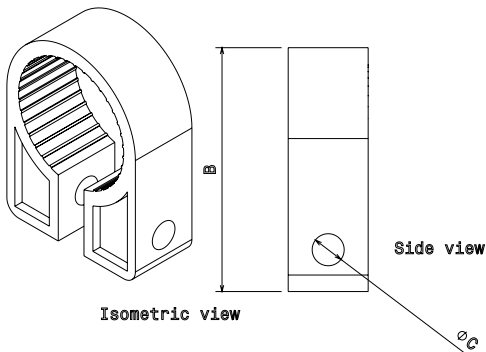
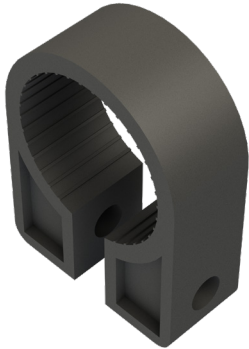

Part No.	A	B	C
C4	15.0	29.0	6.00
C5	17.7	31.0	6.00
C6	20.0	32.7	6.00
C7	22.0	35.0	6.00
C8	24.6	37.0	7.20
C9	26.5	41.3	7.20
C10	29.5	42.0	7.20
C11	32.5	46.4	9.00
C12	36.5	52.0	9.00
C14	42.0	61.7	10.0
C16	48.0	64.0	10.0
C18	52.0	69.0	10.0
C20	54.0	72.0	10.0

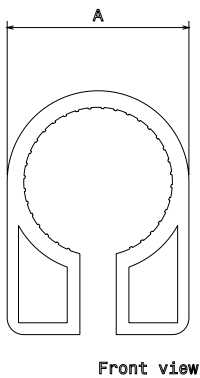

SELECTOR CHART								
	1 Core	2 Core	3 Core	4 Core	7 Core	12 Core	19 Core	27 Core
Cable Type								
Conductor mm²								
1.5		C5	C5	C6	C6	C8	C9	C10
2.5		C6	C6	C6	C7	C9	C10	C12
4		C6	C7	C7	C7	C8	C11	
6		C7	C8	C8				
10		C8	C9	C9				
16		C9	C10	C11				
25		C10	C11	C12				
35		C12	C11	C12				
50	C7	C11	C12	C14				
70	C8	C12	C14	C16				
95	C9	C14	C16	C18				
120	C10	C16	C18	C20				

Warning -This chart is intended as a guide only, cable sizes must be checked prior to cleat selection